

premium hospital beds

(944.E4) MATRIX E40



premium hospital beds

MATRIX E40



IMO



multiplatform controls

caregivers friendly devices

1. HANDSET CONTROL

Featured on IPX6 class type is washable. Highly shock resistant. Provided with a coil cable.

Releases the above functions:

- Back-Rest
- Leg-Rest
- Platform Elevation
- Trendelenburg / Anti-Trend.

Provided with LED to indicate:

- Battery charge level
- Selective Locking Functions.

2. SUPERVISOR CONTROL

Featured on IPX6 class type is washable. Placed on a footend drawer provided with a coil cable, can be placed on the footend board top.

Releases the above functions:

- Back-Rest
- Leg-Rest
- Platform Elevation
- Trendelenburg / Anti-Trend.
- Auto Chair
- Flat
- Auto CPR
- Shock

Provided with LED to indicate:

- Battery charge level
- Selective Locking Functions.

3. FOOT CONTROL

Featured on IPX6 class type is washable. Bilaterally featured allows to control de bed on free hands for enhanced procedures and patient handling.

Releases the above functions:

- Auto Chair
- Platform Elevation
- Auto CPR

4. SIDE-RAIL CONTROLS

Featured on IPX6 class type are washable. Embedded on upper side-rails are composed by 4 controls activated by a GO button by safety purposes.

2 internal for patient
2 external for caregivers

Releases the above functions:

- Back-Rest
- Leg-Rest
- Platform Elevation
- Trendelenburg / Anti-Trend.
- Auto Chair
- Flat
- Auto CPR
- < 30° Back-Rest Alarm.

Provided with LEDs to indicate:
Battery charge level
Selective Locking Functions.



1



2



3



4

enhanced procedures



1. AUTO CHAIR

Automatic release by pressing a single button up to the body seated position (Cardiac Chair) to improve the respiratory function.



2. FLAT

Automatic release by pressing a single button up to the platform maximum height. Ensures an optimal ergonomics caregiver position for patient examinations and procedures.



3. SHOCK

Automatic release by pressing a single button up to maximum Trendelenburg position to revert hypoxia episodes in vital organs.



4. AUTO CPR

Automatic release by pressing a single button dropping all bed articulations and driven the platform up to its minimum height ensuring a fair position to patient cardiopulmonary resuscitation procedure.



3 steps of early mobilization

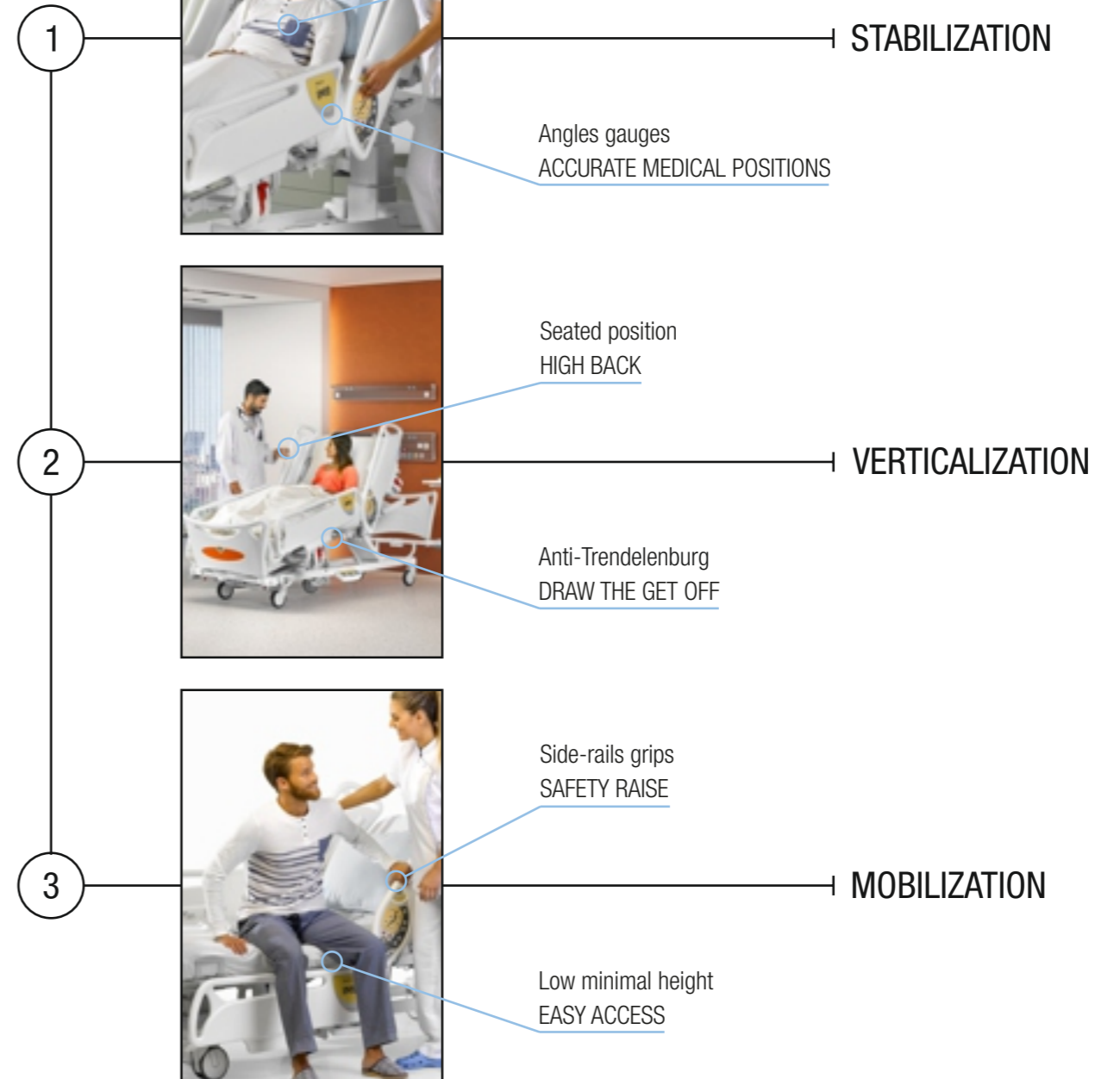

shorter hospitalizations



DOUBLE AUTO-REGRESSION

Platform articulations causes an harmful stress on the patient's abdominal and lumbar body areas. On raising platform articulations a simultaneous synchronized sliding is released (100mm).

PRESURE ULCERS PREVENTION

Mattress platform double auto-regression of back/legs also provides a pelvic and sacro-iliac zone relief, a critical point on pressure sores development.



accurate safety



risk of falls

1. NIGHT LIGHT

Composed by 1 white LED + 1 blue LED. Blue LED turns on when bed reaches minimal height indicating patient is placed on a safe position for a night sleep.

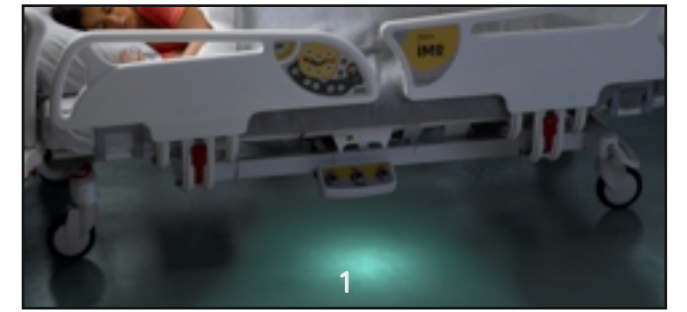

2. LOW MINIMUM HEIGHT

Bed mattress platform achieve 390mm on it's minimum height facilitating the patient entrance and exit. Side-rails retract over the bed platform while folded to create a space clearance about patient legs and feet.



3. STANDARD EN 60601-2-52

The side-rails meet the standard EN60601-2-52. Prevent and avoid the risk of injuries on patient's accidental falls, by a lateral coverage high degree and components has adequate gaps to prevent body entrapping.

emergency releases

1. MANUAL CPR

The bed has bilateral levers to a quick back-rest dropping while a cardiopulmonary reanimation procedure. They are placed on the back-rest section edge corners to an easy access.



2. ENDOTRACHEAL INTUBATION

Head and Foot boards are quickly removable to clear space on intubation procedure. However headboard frame is fixed to the base facilitating endotracheal intubation maneuver by moving the bed to it highest position. Removal headboard is no need.



3. FUNCTIONS SELECTIVE LOCKING

The electrical functions can be locked on Supervisor by safety purposes. The locking keys can be found on the supervisor control, handset control or side-rails controls and lock selectively each motor.



insulation
IPX6

infections control

hospitality



1. MATTRESS PLATFORM

Modular mattress platform made with 11 PPC fiberglass reinforced elements. Extractable for cleaning by an fast clipping system.

2. ONE HAND EXTENSIBLE FOOTEND

The footend board is extensible in 220mm. Just one hand is needed to extend by pressing a rod and then push or pull.

3. BED LINEN RACK

The footend has a retractable rack to support the bed linen exchange service.

washable beds

Featured on IPX6 class, MATRIX E40 beds are suitable to be washed and decontaminated in automatic washing machines.

IPX6 GRADE

Is a water protection grade. Water-proof resistant to cleaning with jet washer devices. Not suitable to full splashdown.

HDECON

Know plus about the IMO new washing machines line for large medical devices.



light handling



smooth transportation

1. POWER CABLE PROTECTION

Frayed cables is number one hospital beds malfunction. MATRIX beds are supplied with a convenient power cable hook to hold on footend board.

2. BACK-UP BATTERY

All MATRIX E40 models are supplied as a standard feature with battery back-up. Set of 2 hermetic batteries (2x1.2 Ah) with a autonomy about 100 cycles or 24 hours in stand-by.

3. GRIP HANDLES

Head and foot boards has been designed with hand grips for an comfortable and ergonomic caregiver transportation.

4. TRANSPORT LOCKING MODE

Head and foot boards has red lockers to provide a more safe transportation for patient and caregivers. Beds may be provided without lockers over client request.

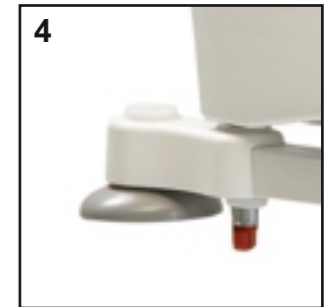
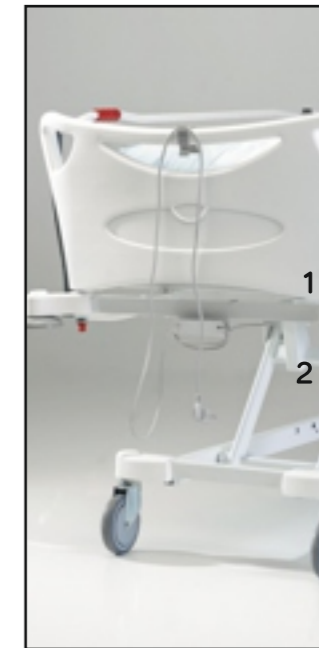

1. CENTRAL LOCKING PEDALS

Placed on booth sides of footend side of the bed.

Has 3 positions:

- Locked (red),
- Unlocked (neutral),
- Directional lock (green).

2. CENTRAL LOCKING BEAM

Placed on footend side of the bed.

Has 3 positions:

- Locked (red),
- Unlocked (neutral),
- Directional lock (green).

3. ADJUSTABLE FIFTH WHEEL

Controlled by the central locking devices is activated on pedals green position. Releases a linear driving (like directional lock) or 360° twist to operate in narrow spaces. Is available with antistatic feature as an option.

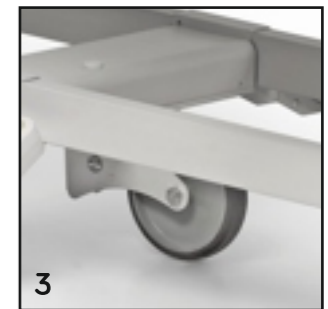
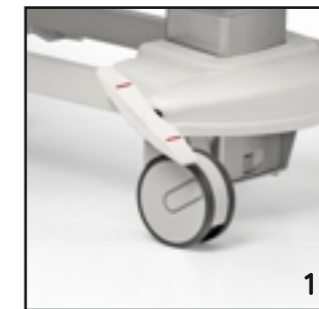

in bed X-ray



X-RAY CASSETTE HOLDER

Beds might incorporate a x-ray cassette holder on back-rest section. Cassette loading is made on the headend. Headboard is no need to be removed, is just to lift mattress platform until it maximum height. Holder has a telescopic sliding full extractable and back-rest section in radiotranslucent made in HPL Compact. Have rullers to adjust to several cassette sizes and types.

brake alarm



TWIN Ø150mm INTEGRAL ABS



SIMPLE Ø150mm SHIELDED ABS



SIMPLE Ø150mm METAL

main features



		STANDARD	OPTION	EXTRA
BED FRAME	Washable IP66 bed frame	●		
	Robust metal frame epoxy coated	●		
	Mobile components zinc plated or/and stainless steel	●		
	Fixed to base head board frame	●		
	Corners protection soft bumpers	●		
	Corners protection plastic fenders	●		
	Bilateral drain bag hooks	●		
MATTRESS PLATFORM	4 sections mattress platform (3 articulated + 1 fixed).	●		
	Modular mattress platform made in PPC easily removable		●	
	Mattress platform boards made in HPL Compact easily removable		●	
	Dual auto-regression sliding	●		
	Plastic mattress shoulders	●		
	Bilateral levers for a quick release manual CPR	●		
	Foot section manually adjustable by a mechanical rack	●		
ROLLING BASE	X-ray cassette holder with translucent HPL back-rest section			●
	Open wide design to avoid dust accumulation	●		
	Edges protection plastic fenders	●		
	ABS twin casters Ø150mm		●	
	ABS simple casters Ø150mm		●	
	Metal simple casters Ø150mm		●	
	Pedals operated central locking system		●	
	Beam operated central locking system		●	
	Adjustable fifth wheel			●
	Adjustable fifth wheel antistatic featured			●
HEAD/FOOT BOARDS	Brake alarm			●
	Made in HDPE (High Density Polyethylene)	●		
	Easily removable	●		
	One hand extensible mattress platform	●		
	Rack to stow supervisor control	●		
	Transportation safety lockers*	●		
SIDE-RAILS	Extensible footend linen rack.			●
	Split side-rails made in HDPE (High Density Polyethylene)	●		
	Angle gauges to measure back and Trend angles	●		
	Collapsible system releasing Gap Zero	●		
ELECTRIC SETUP	Soft drop movement activated by a red pawl	●		
	Motion management controlled by a microprocessed unit	●		
	Low voltage motors DC24V (4 linear actuators)	●		
	Back-up battery (100 cycles) and uncharged alarm	●		
CONTROL	Power cord with store holder and portable plastic hooker	●		
	Side-rails embedded controls (2 exterior + 2 interior)		●	
	Portable handset control		●	
	Supervisor control, portable on footend side	●		
	Bilateral foot control			●
	Nigh light featured on 2 colours (safe night position)			●

STANDARD - included on selected model.

OPTION - included but requires to be selected between several options.

EXTRA - not included, additional feature to join to the selected model.

*removed over client petition



I.V. Rod. Stainless steel column. High adjustable rod with 4 hooks.	910.104I
I.V. Rod. Epoxy coated steel column. High adjustable stainless steel rod with 4 hooks.	910.104



Patient lifting pole. Stainless steel column. Adjustable belt. Ergonomic handle.	910.200
Patient lifting pole. Stainless steel column. Auto-adjustable belt. Ergonomic handle.	910.201



Writing pad. To hang on footend board. Foldable. Metallic frame with HPL Compact table.	910.806
---	---------



Monitor tray. Fitting on footend sockets. Foldable. Metal frame with plastic tray.	910.805
--	---------

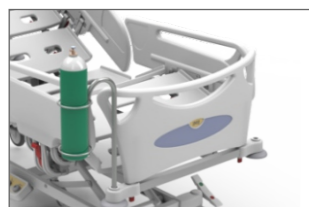

O2 tank holder. Fitting on headend/footend sockets. Stainless steel tube fully made.	910.530
--	---------



Male urinal bottle. Removable. Stainless steel wire fully made.	910.520
Drains/urine bag hooks. Bilateral. Standard on bed metal frame.	Included



Simple traction frame. Settle at the bed's footend. (Weights and cables not included).	910.423
--	---------

The Matrix E40 series does not allow the complete orthopedic frame. Choose in this case the Matrix E30 series.

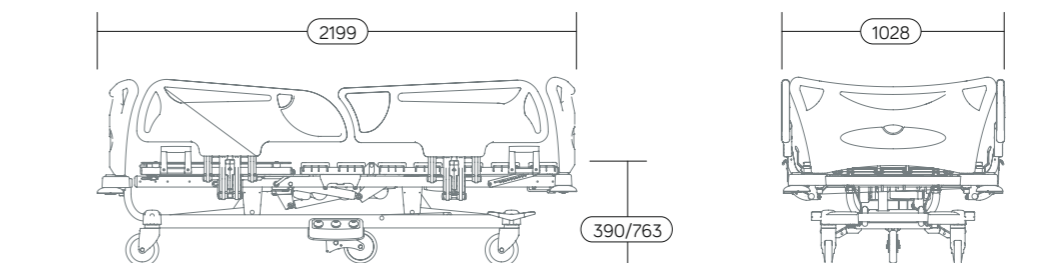

DIMENSIONS (±5%)

Recommended mattress	1970 x 860 mm
External dimensions	2199 x 1000 mm
Raised side-rails width	1028 mm
Platform sections length	
Back-rest	794 mm
Pelvis	240 mm
Leg-rest	292 mm
Foot-rest	574 mm
Minimum/Maximum height	390 / 763 mm*
Platform/side-rails height	375 mm
Maximum auto-regression	100 mm

ARTICULATIONS (±5%)

Back-rest maximum angle	70°
Cardiac Chair	87°
Leg-rest maximum angle	32°
Foot-rest maximum angle	26°
Maximum tilt	
Trendelenburg	17°
Anti-Trendelenburg	17°

CAPABILITIES (±5%)

Patient maximum load	250 Kg
Overall bed weight	114 Kg
Electric tension	230VAC-50/60Hz
Option	110/120VAC-50/60Hz
Maximum electric power	185 W
Batteries electric power	18 W

* ABS Ø150mm simple caster, HPL Compact mattress platform. Plastic (HDPE) mattress platform +20mm.

REGISTRY AND CONFORMITY

Officially registered as Medical Devices Class I, no. 125 / DM / 2017/01/217 - Informed CE Mark

Over the scope of UE directive 2007/47/EE, annex IX

Certified over standard EN ISO 9001 - Quality Management System

Certified over standard EN ISO 13485 - Medical Devices Conception and Manufacturing

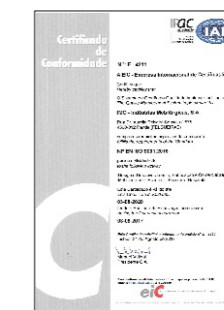
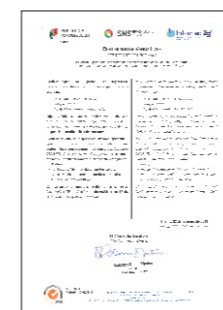

M302



861



431



454

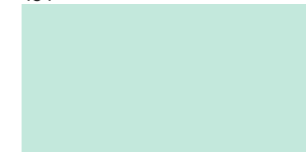

484

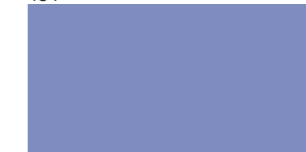

838



Indicative colors only, check with real samples.



IMO-INDUSTRIAS METALURGICAS, S.A.

www.imo.com.pt

HEADQUARTERS & PLANT

Rua Dr. Aurélio Teixeira de Sousa, 575
4650-312 Rande
PORTUGAL
T. +351 255 340 220
porto@imo.com.pt

IMO PORTO

Rua Adolfo Casais Monteiro, 117
4050-520 Porto
Tel. 222 009 767

IMO LISBOA

Av. Defensores de Chaves, 87A
1000-115 Lisboa
Tel. 217 963 478
lisboa@imo.com.pt